

Reversible Motor Drivers for Brush Motors

0.5A or Less Reversible Motor Driver (Single Motor)

BA6950FS



0.8A Reversible Motor Driver (Single Motor)

BA6951FS

No.11008ECT01

●Description

These drivers are reversible motor drivers that can directly drive brush motor which require forward and reverse rotations. Four modes of output setting are available by the use of input logic (2 inputs); forward, reverse, stop (idling), and braking. In addition, since voltage applied to motors varies in accord with the control terminal, motor rotating speed can be optionally set and by the built-in current feedback amplifier, the motor can be driven at a constant speed.

●Features

- 1) Four-mode outputs of forward, reverse, stop (idling), and braking are enabled in compliance with two inputs
- 2) Motors can be driven at a constant speed by a current feedback amplifier
- 3) Built-in thermal shutdown circuit
- 4) Built-in current limiting function (BA6951FS)

●Applications

Audio-visual equipment; PC peripherals; Car audios; Car navigation systems; OA equipments

●Absolute maximum ratings (Ta=25°C, All voltages are with respect to ground)

Parameter	Symbol	Ratings		Unit
		BA6950FS	BA6951FS	
Supply voltage	VCC	8		V
Supply voltage	VB	18		V
Output current	I _{OMAX}	0.4* ¹	0.8* ¹	A
Operating temperature	T _{OPR}	-20 ~ 75		°C
Storage temperature	T _{STG}	-55 ~ 150		°C
Power dissipation	Pd	0.813* ²		W
Junction temperature	T _{jmax}	150		°C

*1 Do not, exceed Pd or ASO.

*2 SSOP-A16 package. Mounted on a 70mm x 70mm x 1.6mm FR4 glass-epoxy board with less than 3% copper foil. Derated at 6.4mW/°C above 25°C.

●Operating conditions (Ta=25°C)

Parameter	Symbol	Ratings	Unit
Supply voltage	VCC	3 ~ 6	V
Supply voltage	VB	3 ~ 16	V
VTCL voltage	V _{CTL}	0 ~ (VCC-1.8)	V

● **Electrical characteristics** (BA6950FS, unless otherwise specified, Ta=25°C and VCC=4.8V, VB=4.8V)

Parameter	Symbol	Limits			Unit	Conditions
		Min.	Typ.	Max.		
Supply current 1	I _{CC1}	-	4.0	6.0	mA	FWD/REV mode, VCTL=0V
Supply current 2	I _{CC2}	-	0.7	1.5	mA	Standby mode, VCTL=0V
Supply current 3	I _{BOFF}	-	0	1	μA	VCC=0V
Input threshold voltage H	V _{R/F H}	2.0	-	VCC	V	
Input threshold voltage L	V _{R/F L}	0	-	0.8	V	
Input bias current	I _{R/F H}	-	80	135	μA	FIN=2V, RIN=2V
CTL amplifier offset voltage	V _{CTLOFS}	-5	0	5	mV	VCTL-RC, VCTL=0V, 1V
CTL amplifier gain	V _{CTLGA}	40	46	52	μA/V	ΔI _{RT1} , VCTL=2V, 1V
CTL output mirror ratio 1	I _{CTLR1}	0.85	1.00	1.15	ratio	I _{RT1} /I _{RC} , I _{RC} =20μA
CTL output mirror ratio 2	I _{CTLR2}	0.90	1.00	1.10	ratio	I _{RT1} /I _{RC} , I _{RC} =200μA
CS amplifier offset voltage	CS _{OFS}	-5	0	5	mV	CS1-CS2, CS1=0V, 0.1V
CS output mirror ratio 1	I _{CSR1}	0.85	1.00	1.15	ratio	I _{RT2} /I _{CS2} , I _{CS} =20μA
CS output mirror ratio 2	I _{CSR2}	0.90	1.00	1.10	ratio	I _{RT2} /I _{CS2} , I _{CS} =200μA
Output high voltage	V _H	2.0	4.6	-	V	M1, M2, VCTL=0.2V
Output saturation voltage H	V _{OH}	-	0.09	0.3	V	I _O =50mA, RT1=VCC
Output saturation voltage L	V _{OL}	-	0.07	0.2	V	I _O =50mA, RT1=VCC

● **Electrical characteristics** (BA6951FS, unless otherwise specified, Ta=25°C and VCC=4.8V, VB=4.8V)

Parameter	Symbol	Limits			Unit	Conditions
		Min.	Typ.	Max.		
Supply current 1	I _{CC1}	-	4.0	6.0	mA	FWD/REV mode, VCTL=0V
Supply current 2	I _{CC2}	-	0.7	1.5	mA	Standby mode, VCTL=0V
Supply current 3	I _{BOFF}	-	0	1	μA	VCC=0V
Input threshold voltage H	V _{R/F H}	2.0	-	VCC	V	
Input threshold voltage L	V _{R/F L}	0	-	0.8	V	
Input bias current	I _{R/F H}	-	80	135	μA	FIN=2V, RIN=2V
CTL amplifier offset voltage	V _{CTLOFS}	-5	0	5	mV	VCTL-RC, VCTL=0V, 1V
CTL amplifier gain	V _{CTLGA}	40	46	52	μA/V	ΔI _{RT1} , VCTL=2V, 1V
CTL output mirror ratio 1	I _{CTLR1}	0.85	1.00	1.15	ratio	I _{RT1} /I _{RC} , I _{RC} =20μA
CTL output mirror ratio 2	I _{CTLR2}	0.90	1.00	1.10	ratio	I _{RT1} /I _{RC} , I _{RC} =200μA
CS amplifier offset voltage	CS _{OFS}	-5	0	5	mV	ATC-CS, ATC=0V, 0.1V
CS output mirror ratio 1	I _{CSR1}	0.85	1.00	1.15	ratio	I _{RT2} /I _{CS} , I _{CS} =20μA
CS output mirror ratio 2	I _{CSR2}	0.90	1.00	1.10	ratio	I _{RT2} /I _{CS} , I _{CS} =200μA
TL-R _{AOFS} offset voltage	TL-R _{AOFS}	6	18	30	mV	TL=0.3V, R _{ATC} =1.0Ω
Output high voltage	V _H	1.85	2.20	2.55	V	M1, M2, VCTL=1.0V
Output saturation voltage H	V _{OH}	-	0.28	0.56	V	I _O =300mA, RT1=VCC
Output saturation voltage L	V _{OL}	-	0.32	0.64	V	I _O =300mA, RT1=VCC

●Electrical characteristic curves (Reference data)

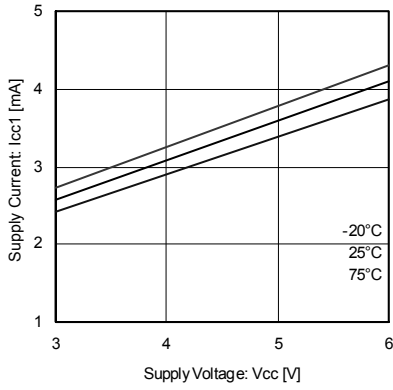

Fig.1 Supply current 1 (Forward) (BA6950FS)

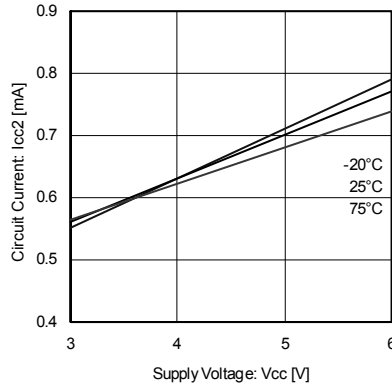

Fig.2 Supply current 2 (Standby) (BA6950FS)

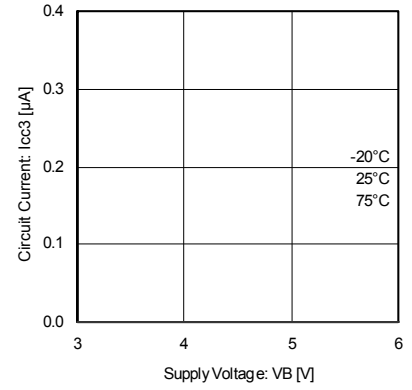

Fig.3 Supply current 3 (BA6950FS)

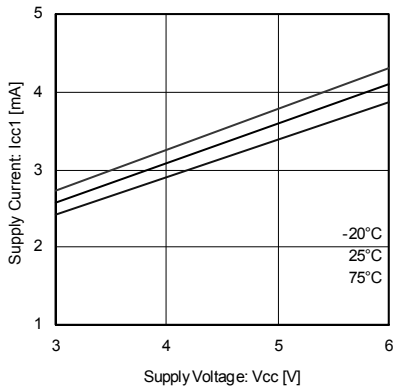

Fig.4 Supply current 1 (Forward) (BA6951FS)

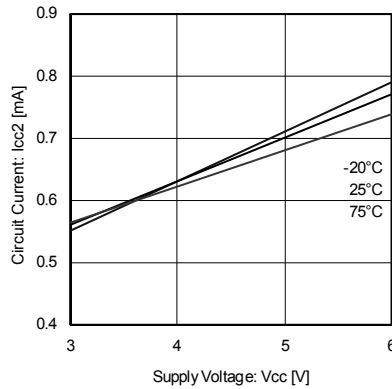

Fig.5 Supply current 2 (Standby) (BA6951FS)

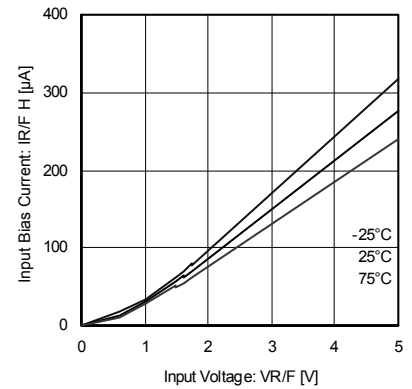

Fig.6 Input bias current (BA6950FS)

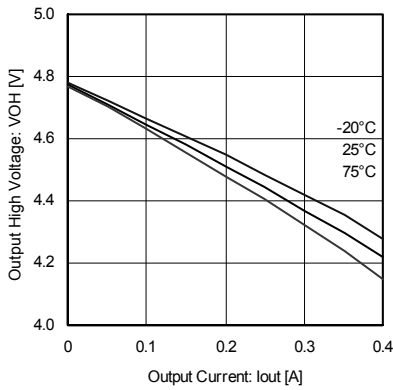

Fig.7 Output saturation voltage H (BA6950FS)

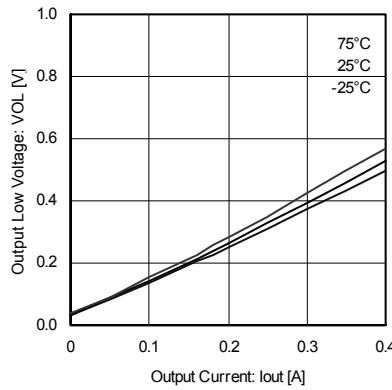

Fig.8 Output saturation voltage L (BA6950FS)

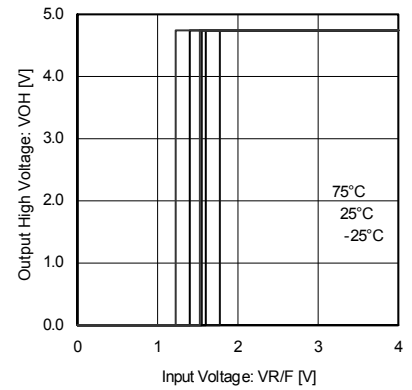

Fig.9 Input threshold voltage (BA6950FS)

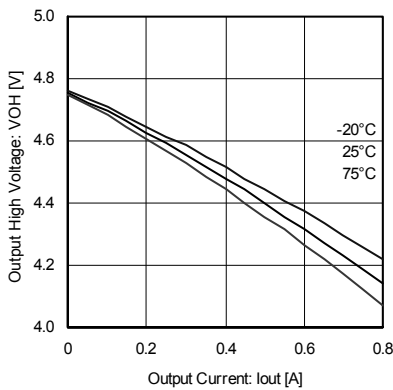

Fig.10 Output saturation voltage H (BA6951FS)

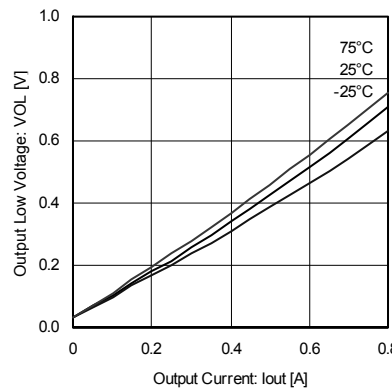

Fig.11 Output saturation voltage L (BA6951FS)

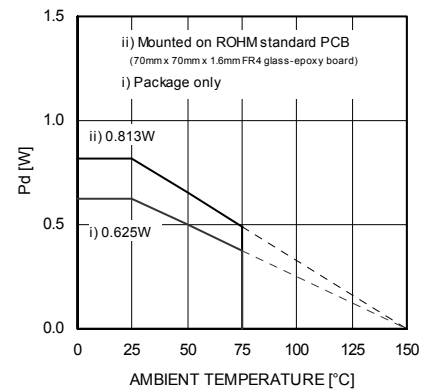

Fig.12 Thermal derating curve (SSOP-A16)

●Block diagram and pin configuration

BA6950FS

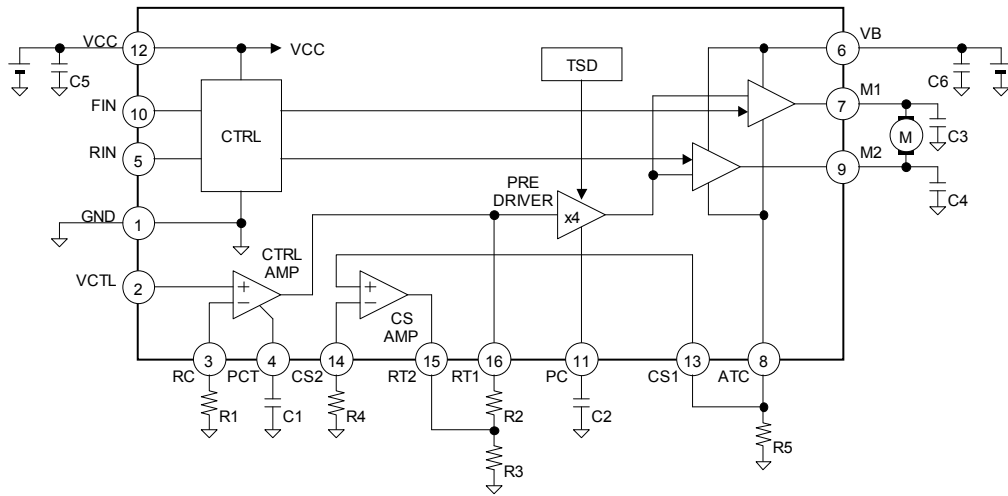

Fig.13 BA6950FS

Table 1 BA6950FS

Pin	Name	Function
1	GND	GND
2	VCTL	Control input
3	RC	Control gain setting
4	PCT	CTL amp phase compensation
5	RIN	Control input (reverse)
6	VB	Power supply (driver stage)
7	M1	Driver output
8	ATC	Current sense pin
9	M2	Driver output
10	FIN	Control input (forward)
11	PC	Phase compensation
12	VCC	Power supply (small signal)
13	CS1	CS amp gain setting
14	CS2	CS amp gain setting
15	RT2	CTL amp gain setting
16	RT1	CTL amp gain setting

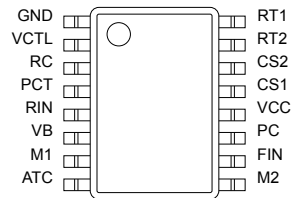

Fig.14 BA6950FS (SSOP-A16)

●Block diagram and pin configuration

BA6951FS

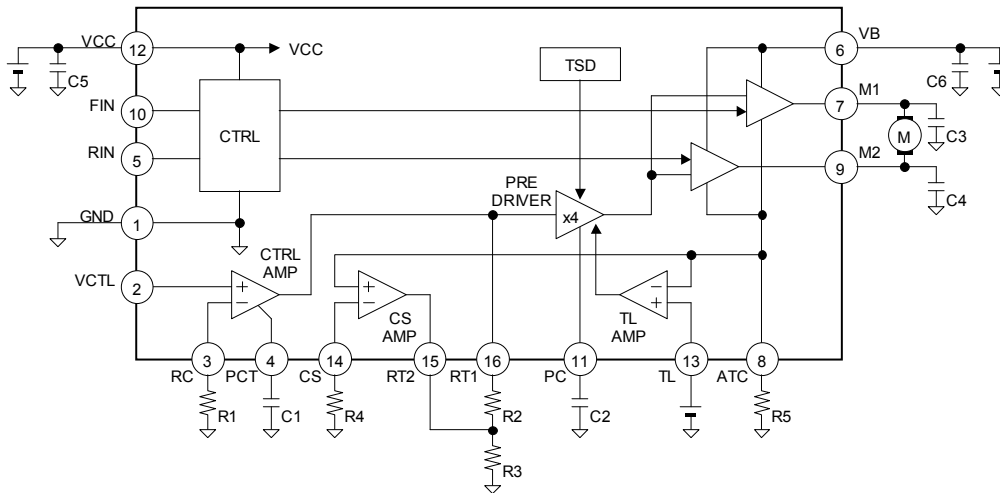

Fig.15 BA6951FS

Table 2 BA6951FS

Pin	Name	Function
1	GND	GND
2	VCTL	Control input
3	RC	Control gain setting
4	PCT	CTL amp phase compensation
5	RIN	Control input (reverse)
6	VB	Power supply (driver stage)
7	M1	Driver output
8	ATC	Current sense pin
9	M2	Driver output
10	FIN	Control input (forward)
11	PC	Phase compensation
12	VCC	Power supply (small signal)
13	TL	Torque limiter setting
14	CS	CS amp gain setting
15	RT2	CTL amp gain setting
16	RT1	CTL amp gain setting

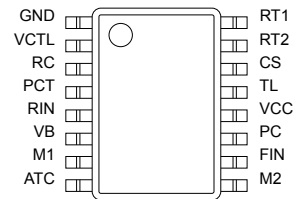

Fig.16 BA6951FS (SSOP-A16)

●External application components

- 1) Resistor for the current sensing, R5
This is a current sensing resistor, care must be taken to avoid changes in the ground wire pattern in any external connected component.
- 2) Control amplifier gain setting resistor, R1
VCTL pin voltage is buffered to RC pin, and the control gain - V_{CTLGA} - can be set by connecting R1. The current decided here is output to RT1 pin.
- 3) Control amplifier phase compensation capacitor, C1
This phase compensation capacitor for the control amplifier. Please monitor the RT1 pin voltage and confirm no oscillation. About 33pF is recommended.
- 4) Current feedback amplifier gain setting resistor, R4
CS1 pin voltage (the motor current detection) is buffered to CS2 pin - BA6950FS.
ATC pin voltage (the motor current detection) is buffered to CS pin - BA6951FS.
The current feedback gain can be set by R4 connecting to CS2 or CS pin. The current decided here is output to RT2 pin.
- 5) Pre-amplifier gain setting resistor, R2, R3
These resistors are to add the control amplifier output and the current feedback amplifier output. This amplifier has about fourfold gain.
- 6) Pre-amplifier phase compensation capacitor, C2
Please connect the capacitor about 0.1 μ F as the phase compensation of the pre-amplifier, and monitor the driver output no oscillation.
- 7) Stabilization capacitor for the power supply line, C5, C6
Please connect the capacitor of 1 μ F to 100 μ F for the stabilization of the power supply line, and confirm the motor operation.
- 8) Phase compensating capacitor, C3, C4
Noise is generated in output pins or oscillation results in accord with the set mounting state such as power supply circuit, motor characteristics, PCB pattern artwork, etc. As noise oscillation measures, connect 0.01 μ F to 0.1 μ F capacitors.
- 9) Torque limiter setting, TL pin, BA6951FS only
The motor current is limited so that ATC pin voltage should not exceed TL pin voltage.

●Functional descriptions

Table 3 Logic table

FIN	RIN	M1	M2	Operation
L	L	OPEN*	OPEN*	Stop (idling)
H	L	L	H	Forward (M2 > M1)
L	H	H	L	Reverse (M1 > M2)
H	H	L	L	Brake (stop)

* OPEN is the off state of all output transistors. Please note that this is the state of the connected diodes, which differs from that of the mechanical relay.

●External application components setting procedure

The relation between VCTL and the output high voltage is as follows.

- $I_{RT1} = V_{CTL} / R1$ (1) VCTL: Torque control voltage
- $I_{RT2} = I_{ACT} \times R5 / R4$ (2) IACT: Motor current
- $V_{RT1} = R3 \times (I_{RT1} + I_{RT2}) + R2 \times I_{RT1}$ (3)
- $V_{MX} = 4 \times V_{RT1}$ (4) V_{M1}, V_{M2} : Output high voltage

$$V_{MX} = \frac{4 (R2 + R3)}{R1} \times V_{CTL} + \frac{4 R3 R5}{R4} \times I_{ACT} \quad \dots (5)$$

To drive the motor by constant speed as follows.

$$R_L + R_{ON} + R5 = \frac{4 R3 R5}{R4} \quad \dots (6) \quad \begin{matrix} R_L: \text{Motor coil impedance} \\ R_{ON}: \text{On resistance of the driver IC} \end{matrix}$$

R3, R4, and R5 are first set, and then R1 and R2 are set afterwards.

Table 4 External components

Parts	Default value	Parameter	Recommended condition
R1	22kΩ	I_{RT1}	$I_{RT1} < 1\text{mA}$
R2 + R3	1kΩ + 1.5kΩ	V_{RT1}	$V_{RT1} \times 4 < V_B$
R4	560Ω	I_{RT2}	$I_{RT2} < 1\text{mA}$
R5	5.5Ω	V_{ATC}	$V_{ATC} < 1\text{V}$
C1	33pF	V_{PCT}	Please confirm the motor operation
C2	0.1μF	V_{PC}	
C3, C4	0.1μF	V_{M1}, V_{M2}	
C5, C6	1~100μF	VCC, VB	

●Interfaces

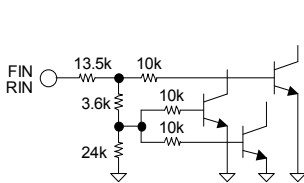

Fig. 17 FIN, RIN

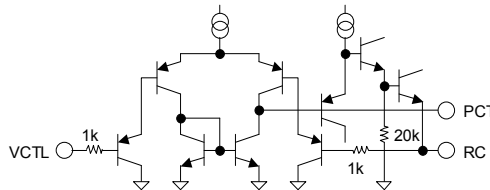

Fig.18 VCTL, RC, PCT

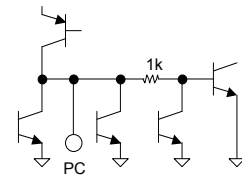

Fig.19 PC

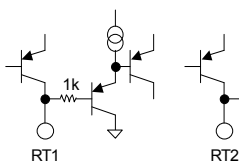

Fig. 20 RT1, RT2

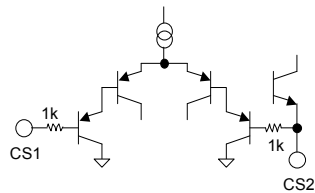

Fig.21 CS1, CS2 (BA6950FS)

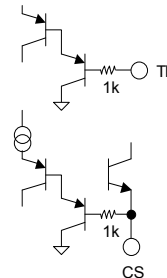

Fig.22 CS, TL (BA6951FS)

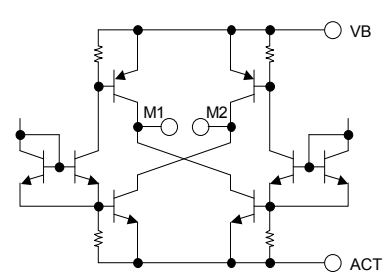

Fig.23 VB, ACT, M1,M2

●Notes for use

- 1) **Absolute maximum ratings**

Devices may be destroyed when supply voltage or operating temperature exceeds the absolute maximum rating. Because the cause of this damage cannot be identified as, for example, a short circuit or an open circuit, it is important to consider circuit protection measures – such as adding fuses – if any value in excess of absolute maximum ratings is to be implemented.
- 2) **Connecting the power supply connector backward**

Connecting the power supply in reverse polarity can damage the IC. Take precautions against reverse polarity when connecting the power supply lines, such as adding an external direction diode.
- 3) **Power supply lines**

Return current generated by the motor's Back-EMF requires countermeasures, such as providing a return current path by inserting capacitors across the power supply and GND (10 μ F, ceramic capacitor is recommended). In this case, it is important to conclusively confirm that none of the negative effects sometimes seen with electrolytic capacitors – including a capacitance drop at low temperatures - occurs. Also, the connected power supply must have sufficient current absorbing capability. Otherwise, the regenerated current will increase voltage on the power supply line, which may in turn cause problems with the product, including peripheral circuits exceeding the absolute maximum rating. To help protect against damage or degradation, physical safety measures should be taken, such as providing a voltage clamping diode across the power supply and GND.
- 4) **Electrical potential at GND**

Keep the GND terminal potential to the minimum potential under any operating condition. In addition, check to determine whether there is any terminal that provides voltage below GND, including the voltage during transient phenomena. When both a small signal GND and high current GND are present, single-point grounding (at the set's reference point) is recommended, in order to separate the small signal and high current GND, and to ensure that voltage changes due to the wiring resistance and high current do not affect the voltage at the small signal GND. In the same way, care must be taken to avoid changes in the GND wire pattern in any external connected component.
- 5) **Thermal design**

Use a thermal design that allows for a sufficient margin in light of the power dissipation (Pd) under actual operating conditions.
- 6) **Inter-pin shorts and mounting errors**

Use caution when positioning the IC for mounting on printed circuit boards. The IC may be damaged if there is any connection error, or if pins are shorted together.
- 7) **Operation in strong electromagnetic fields**

Using this product in strong electromagnetic fields may cause IC malfunctions. Use extreme caution with electromagnetic fields.
- 8) **ASO - Area of Safety Operation**

When using the IC, set the output transistor so that it does not exceed absolute maximum ratings or ASO.
- 9) **Built-in thermal shutdown (TSD) circuit**

The TSD circuit is designed only to shut the IC off to prevent thermal runaway. It is not designed to protect the IC or guarantee its operation in the presence of extreme heat. Do not continue to use the IC after the TSD circuit is activated, and do not operate the IC in an environment where activation of the circuit is assumed.
- 10) **Capacitor between output and GND**

In the event a large capacitor is connected between the output and GND, if VCC and VIN are short-circuited with 0V or GND for any reason, the current charged in the capacitor flows into the output and may destroy the IC. Use a capacitor smaller than 0.47 μ F between output and GND.
- 11) **Testing on application boards**

When testing the IC on an application board, connecting a capacitor to a low impedance pin subjects the IC to stress. Therefore, always discharge capacitors after each process or step. Always turn the IC's power supply off before connecting it to or removing it from the test setup during the inspection process. Ground the IC during assembly steps as an antistatic measure. Use similar precaution when transporting or storing the IC.
- 12) **Switching of rotating direction (FWD/REV)**

When the rotating direction is changed over by the motor rotating condition, switch the direction after the motor is temporarily brought to the BRAKE condition or OPEN condition. It is recommended to keep the relevant conditions as follows: via BRAKE: Longer than braking time*.
(* the time required for the output voltage to achieve potential below GND when brake is activated.)
via OPEN: The time longer than 1 ms is recommended.

13) Regarding the input pin of the IC

This monolithic IC contains P+ isolation and P substrate layers between adjacent elements, in order to keep them isolated. P-N junctions are formed at the intersection of these P layers with the N layers of other elements, creating a parasitic diode or transistor.

For example, the relation between each potential is as follows:
 When $GND > Pin A$ and $GND > Pin B$, the P-N junction operates as a parasitic diode.
 When $GND > Pin B$, the P-N junction operates as a parasitic transistor.

Parasitic diodes inevitably occur in the structure of the IC. The operation of parasitic diodes can result in mutual interference among circuits, as well as operating malfunctions and physical damage. Therefore, do not use methods by which parasitic diodes operate, such as applying a voltage lower than the GND (P substrate) voltage to an input pin.

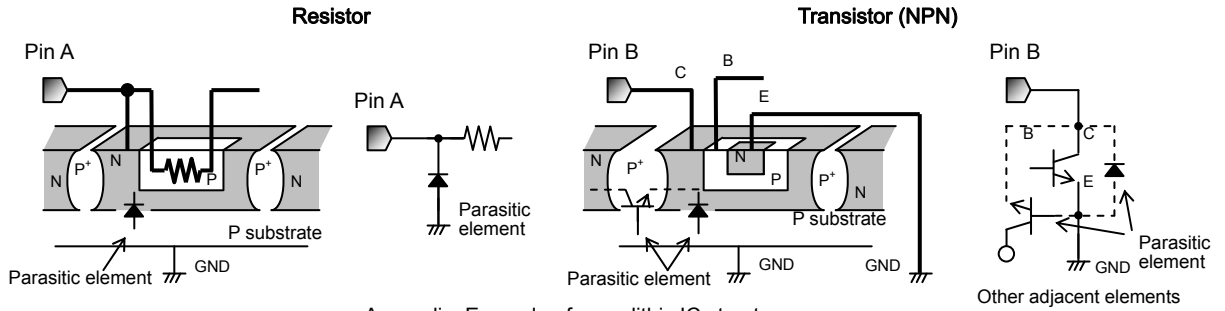

Appendix: Example of monolithic IC structure

●Ordering part number

B	A
---	---

Part No.

6	9	5	0
---	---	---	---

Part No.
6950
6951

F	S
---	---

Package
FS: SSOP-A16

E	2
---	---

Packaging and forming specification
E2: Embossed tape and reel

SSOP-A16

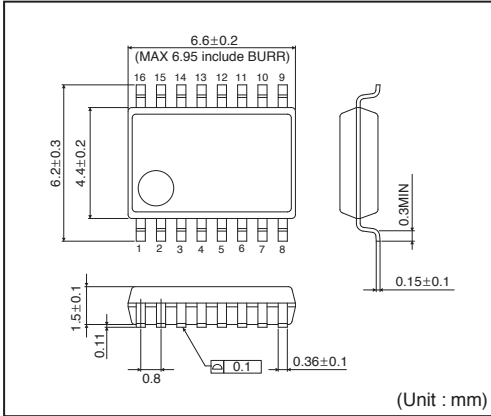

<Tape and Reel information>

Tape	Embossed carrier tape
Quantity	2500pcs
Direction of feed	E2 (The direction is the 1 pin of product is at the upper left when you hold reel on the left hand and you pull out the tape on the right hand)

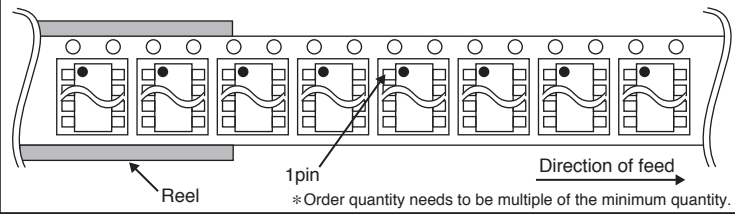

Notice

Precaution on using ROHM Products

- Our Products are designed and manufactured for application in ordinary electronic equipments (such as AV equipment, OA equipment, telecommunication equipment, home electronic appliances, amusement equipment, etc.). If you intend to use our Products in devices requiring extremely high reliability (such as medical equipment ^(Note 1), transport equipment, traffic equipment, aircraft/spacecraft, nuclear power controllers, fuel controllers, car equipment including car accessories, safety devices, etc.) and whose malfunction or failure may cause loss of human life, bodily injury or serious damage to property ("Specific Applications"), please consult with the ROHM sales representative in advance. Unless otherwise agreed in writing by ROHM in advance, ROHM shall not be in any way responsible or liable for any damages, expenses or losses incurred by you or third parties arising from the use of any ROHM's Products for Specific Applications.

(Note1) Medical Equipment Classification of the Specific Applications

JAPAN	USA	EU	CHINA
CLASS III	CLASS III	CLASS II b	CLASS III
CLASS IV		CLASS III	

- ROHM designs and manufactures its Products subject to strict quality control system. However, semiconductor products can fail or malfunction at a certain rate. Please be sure to implement, at your own responsibilities, adequate safety measures including but not limited to fail-safe design against the physical injury, damage to any property, which a failure or malfunction of our Products may cause. The following are examples of safety measures:
 - Installation of protection circuits or other protective devices to improve system safety
 - Installation of redundant circuits to reduce the impact of single or multiple circuit failure
- Our Products are designed and manufactured for use under standard conditions and not under any special or extraordinary environments or conditions, as exemplified below. Accordingly, ROHM shall not be in any way responsible or liable for any damages, expenses or losses arising from the use of any ROHM's Products under any special or extraordinary environments or conditions. If you intend to use our Products under any special or extraordinary environments or conditions (as exemplified below), your independent verification and confirmation of product performance, reliability, etc. prior to use, must be necessary:
 - Use of our Products in any types of liquid, including water, oils, chemicals, and organic solvents
 - Use of our Products outdoors or in places where the Products are exposed to direct sunlight or dust
 - Use of our Products in places where the Products are exposed to sea wind or corrosive gases, including Cl₂, H₂S, NH₃, SO₂, and NO₂
 - Use of our Products in places where the Products are exposed to static electricity or electromagnetic waves
 - Use of our Products in proximity to heat-producing components, plastic cords, or other flammable items
 - Sealing or coating our Products with resin or other coating materials
 - Use of our Products without cleaning residue of flux (even if you use no-clean type fluxes, cleaning residue of flux is recommended); or Washing our Products by using water or water-soluble cleaning agents for cleaning residue after soldering
 - Use of the Products in places subject to dew condensation
- The Products are not subject to radiation-proof design.
- Please verify and confirm characteristics of the final or mounted products in using the Products.
- In particular, if a transient load (a large amount of load applied in a short period of time, such as pulse. is applied, confirmation of performance characteristics after on-board mounting is strongly recommended. Avoid applying power exceeding normal rated power; exceeding the power rating under steady-state loading condition may negatively affect product performance and reliability.
- De-rate Power Dissipation (Pd) depending on Ambient temperature (Ta). When used in sealed area, confirm the actual ambient temperature.
- Confirm that operation temperature is within the specified range described in the product specification.
- ROHM shall not be in any way responsible or liable for failure induced under deviant condition from what is defined in this document.

Precaution for Mounting / Circuit board design

- When a highly active halogenous (chlorine, bromine, etc.) flux is used, the residue of flux may negatively affect product performance and reliability.
- In principle, the reflow soldering method must be used; if flow soldering method is preferred, please consult with the ROHM representative in advance.

For details, please refer to ROHM Mounting specification

Precautions Regarding Application Examples and External Circuits

1. If change is made to the constant of an external circuit, please allow a sufficient margin considering variations of the characteristics of the Products and external components, including transient characteristics, as well as static characteristics.
2. You agree that application notes, reference designs, and associated data and information contained in this document are presented only as guidance for Products use. Therefore, in case you use such information, you are solely responsible for it and you must exercise your own independent verification and judgment in the use of such information contained in this document. ROHM shall not be in any way responsible or liable for any damages, expenses or losses incurred by you or third parties arising from the use of such information.

Precaution for Electrostatic

This Product is electrostatic sensitive product, which may be damaged due to electrostatic discharge. Please take proper caution in your manufacturing process and storage so that voltage exceeding the Products maximum rating will not be applied to Products. Please take special care under dry condition (e.g. Grounding of human body / equipment / solder iron, isolation from charged objects, setting of Ionizer, friction prevention and temperature / humidity control).

Precaution for Storage / Transportation

1. Product performance and soldered connections may deteriorate if the Products are stored in the places where:
 - [a] the Products are exposed to sea winds or corrosive gases, including Cl₂, H₂S, NH₃, SO₂, and NO₂
 - [b] the temperature or humidity exceeds those recommended by ROHM
 - [c] the Products are exposed to direct sunshine or condensation
 - [d] the Products are exposed to high Electrostatic
2. Even under ROHM recommended storage condition, solderability of products out of recommended storage time period may be degraded. It is strongly recommended to confirm solderability before using Products of which storage time is exceeding the recommended storage time period.
3. Store / transport cartons in the correct direction, which is indicated on a carton with a symbol. Otherwise bent leads may occur due to excessive stress applied when dropping of a carton.
4. Use Products within the specified time after opening a humidity barrier bag. Baking is required before using Products of which storage time is exceeding the recommended storage time period.

Precaution for Product Label

QR code printed on ROHM Products label is for ROHM's internal use only.

Precaution for Disposition

When disposing Products please dispose them properly using an authorized industry waste company.

Precaution for Foreign Exchange and Foreign Trade act

Since our Products might fall under controlled goods prescribed by the applicable foreign exchange and foreign trade act, please consult with ROHM representative in case of export.

Precaution Regarding Intellectual Property Rights

1. All information and data including but not limited to application example contained in this document is for reference only. ROHM does not warrant that foregoing information or data will not infringe any intellectual property rights or any other rights of any third party regarding such information or data. ROHM shall not be in any way responsible or liable for infringement of any intellectual property rights or other damages arising from use of such information or data.:
2. No license, expressly or implied, is granted hereby under any intellectual property rights or other rights of ROHM or any third parties with respect to the information contained in this document.

Other Precaution

1. This document may not be reprinted or reproduced, in whole or in part, without prior written consent of ROHM.
2. The Products may not be disassembled, converted, modified, reproduced or otherwise changed without prior written consent of ROHM.
3. In no event shall you use in any way whatsoever the Products and the related technical information contained in the Products or this document for any military purposes, including but not limited to, the development of mass-destruction weapons.
4. The proper names of companies or products described in this document are trademarks or registered trademarks of ROHM, its affiliated companies or third parties.

General Precaution

1. Before you use our Products, you are requested to carefully read this document and fully understand its contents. ROHM shall not be in any way responsible or liable for failure, malfunction or accident arising from the use of any ROHM's Products against warning, caution or note contained in this document.
2. All information contained in this document is current as of the issuing date and subject to change without any prior notice. Before purchasing or using ROHM's Products, please confirm the latest information with a ROHM sales representative.
3. The information contained in this document is provided on an "as is" basis and ROHM does not warrant that all information contained in this document is accurate and/or error-free. ROHM shall not be in any way responsible or liable for any damages, expenses or losses incurred by you or third parties resulting from inaccuracy or errors of or concerning such information.